

# sealed maintenance-free lead-acid **TECHNOCELL** battery **TCL** series



## TCL 35-12

Batteries made in **AGM technology** - electrolyte is absorbed in highly porous fiber glass separators placed between the plates. One-way, self-regulating pressure relief valves prevent the case from blowing up, by preventing excessive buildup of pressure in the cells. They have a low internal resistance, which means a longer working time.

### MAIN APPLICATIONS

- uninterruptible power supplies
- cash registers and fiscal printers
- telecommunication PABX
- marine
- fire and security systems
- emergency lighting systems
- golf-carts, wheelchairs
- solar powered systems

### TECHNICAL DATA

Nominal voltage	12 V
Nominal capacity	35Ah/C <sub>10</sub> 1,80V/cell @25°C
Designed life	6-8 years @ 25°C 10-12 years @ 20°C according Eurobat, Long Life group
Weight	~ 11,5 kg
Internal resistance	~ 12,5 mΩ*
<b>Dimensions</b>	
Height	167 mm
Length	195 mm
Width	130 mm
<b>Charging voltage @ 25°C</b>	
Standby use	13,6 V - 13,8 V (-18mV/°C)
Cycle use	14,6 V - 14,8 V (-24mV/°C)
<b>Charging current</b>	
Recommended	3,5 A
Maximum	8,8 A
Max. discharge current (5s)	420 A
<b>Ambient nominal temperature range</b>	
Storage	-20°C - 60°C
Charge	0°C - 50°C
Discharge	-20°C - 60°C
<b>Container material</b>	
Standard	ABS UL 94-HB
Optional	ABS UL 94-V0

\*for a fully charged battery

### DISCHARGE CHARACTERISTICS

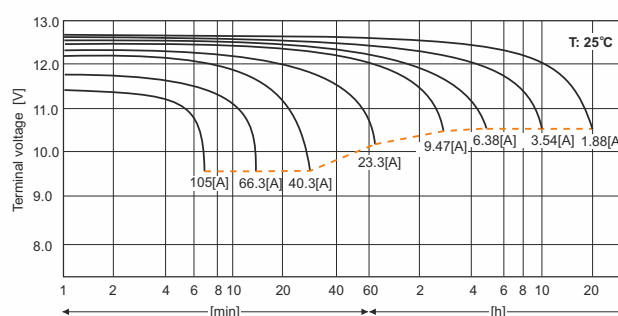

### DIMENSIONS

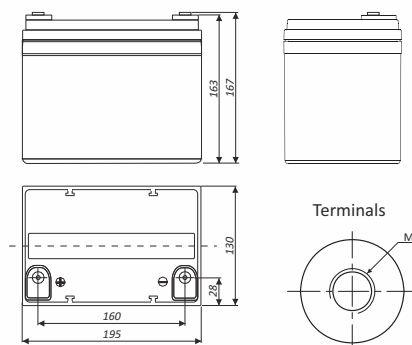

### Constant current discharge (Current [A], 25 [°C] / 77 [°F])

U <sub>f</sub> [V/cell]	Discharge time											
	5 min	10 min	15 min	30min	1h	2h	3h	4h	5h	8h	10h	20h
1,75	106,0	76,4	60,8	38,6	22,9	13,1	9,47	7,47	6,38	4,22	3,54	1,88
1,70	115,0	80,5	62,9	38,9	23,3	13,3	9,57	7,55	6,45	4,25	3,57	1,89
1,65	120,0	83,5	64,2	39,6	23,4	13,4	9,71	7,66	6,52	4,29	3,61	1,90

### Constant power discharge (Power [W/cell], 25 [°C] / 77 [°F])

U <sub>f</sub> [V/cell]	Discharge time											
	5 min	10 min	15 min	30min	1h	2h	3h	4h	5h	8h	10h	20h
1,75	184,0	139,8	113,0	71,9	43,5	25,2	18,2	14,26	12,2	8,23	6,79	3,73
1,70	198,0	142,0	113,0	72,2	43,9	25,4	18,3	14,33	12,3	8,30	6,86	3,75
1,65	199,0	146,1	115,0	72,2	44,2	25,5	18,4	14,52	12,4	8,33	6,93	3,76

U<sub>f</sub> - Final voltage

# TECHNOCELL

www.emu.com.pl



Help restore balance in nature.  
Recycle the used battery.